

MIG / MAG Automatenbrenner

Machine Torches / Torches de soudage automatique / Antorchas para autómatas

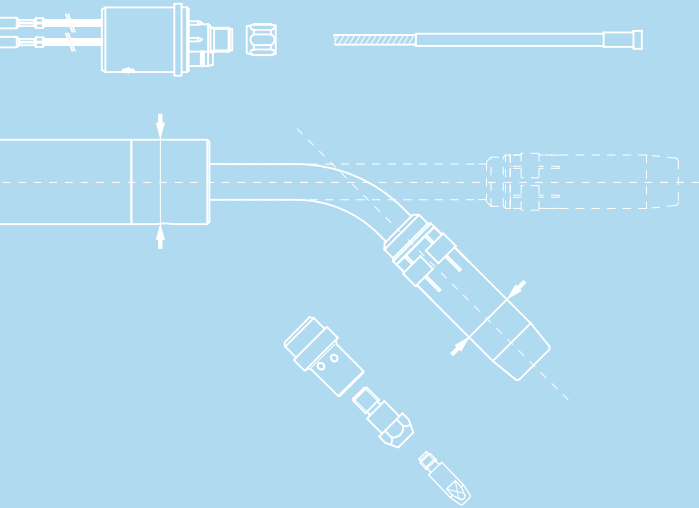

Luft- und wassergekühlt

Air and water cooled

Refroidies par air et eau

Refrigeradas por aire y agua

Standardlänge des Schlauchpakets:
1 / 1.5 / 2 / 2.5 / 3 / 4 / 5 m mit Euro-Zentral-anschluss. Andere Ausführungen auf Anfrage.

Standard length of the cable assembly:
1 / 1.5 / 2 / 2.5 / 3 / 4 / 5 m with Euro central connector. Other versions on request.

Longueur standard du faisceau:
1 / 1.5 / 2 / 2.5 / 3 / 4 / 5 m avec raccord central Euro. Autres versions sur demande.

Longitud estándar del paquete de mangueras:
1 / 1.5 / 2 / 2.5 / 3 / 4 / 5 m con Euro conector. Otras versiones bajo solicitud.



TBi 360 Aut 0°



TBi 9W Aut 45°

Top 2000

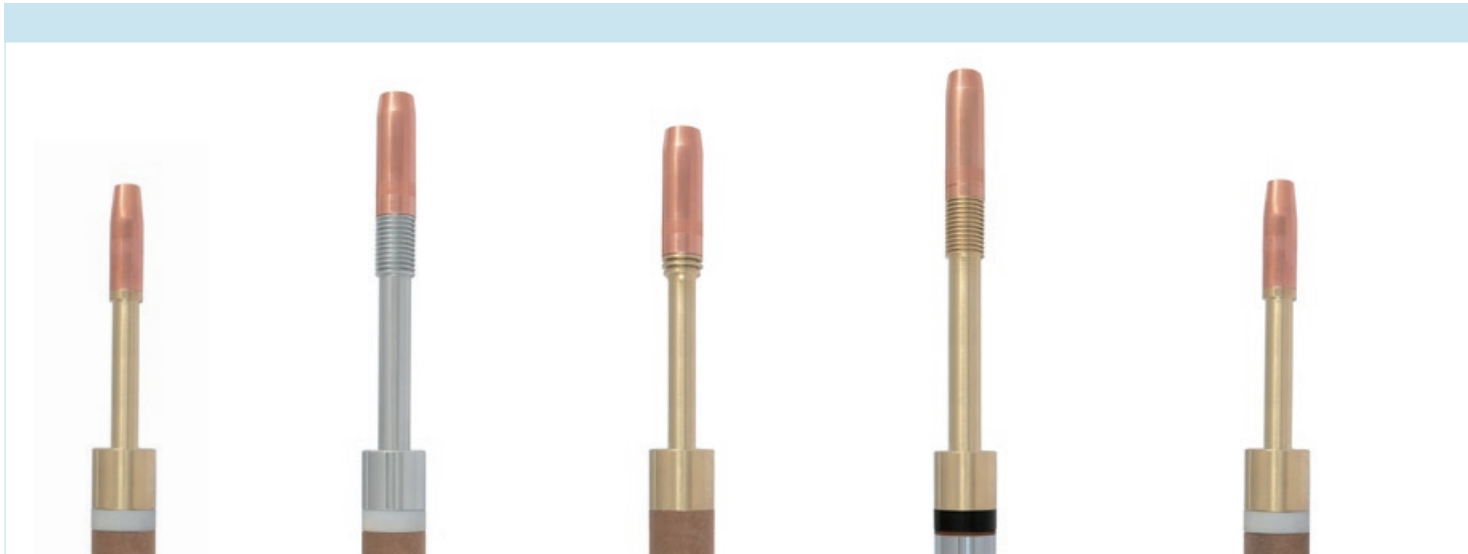

TBi 5G Aut

60% (10 min.)
Mix: 235 A
CO₂: 265 A
Ø 0.8-1.2 mm

luftgekühlt
air cooled /
refroidissement par air /
refrigerada por aire

TBi 6G Aut

60% (10 min.)
Mix: 400 A
CO₂: 435 A
Ø 1.0-1.6 mm

luftgekühlt
air cooled /
refroidissement par air /
refrigerada por aire

TBi 7G Aut

60% (10 min.)
Mix: 335 A
CO₂: 360 A
Ø 1.0-1.2 mm

luftgekühlt
air cooled /
refroidissement par air /
refrigerada por aire

TBi 8G Aut

60% (10 min.)
Mix: 450 A
CO₂: 485 A
Ø 1.2-3.2 mm

luftgekühlt
air cooled /
refroidissement par air /
refrigerada por aire

TBi 5W Aut

100% (10 min.)
Mix: 300 A
CO₂: 350 A
Ø 0.8-1.2 mm

wassergekühlt
water cooled /
refroidissement par eau /
refrigerada por agua

Classic

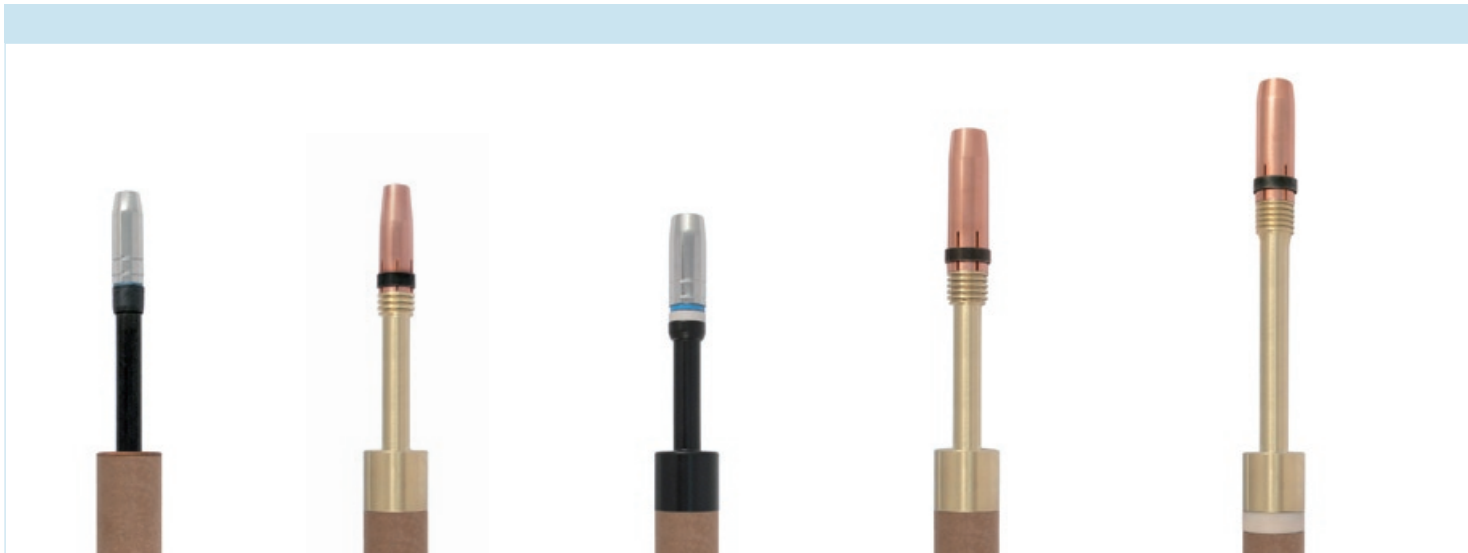

TBi 150 Aut

60% (10 min.)
Mix: 150 A
CO₂: 180 A
Ø 0.6-1.0 mm

luftgekühlt
air cooled /
refroidissement par air /
refrigerada por aire

TBi 240 Aut

60% (10 min.)
Mix: 235 A
CO₂: 265 A
Ø 0.8-1.2 mm

luftgekühlt
air cooled /
refroidissement par air /
refrigerada por aire

TBi 250 Aut

60% (10 min.)
Mix: 200 A
CO₂: 230 A
Ø 0.8-1.2 mm

luftgekühlt
air cooled /
refroidissement par air /
refrigerada por aire

TBi 360 Aut

60% (10 min.)
Mix: 335 A
CO₂: 350 A
Ø 1.0-1.2 mm

luftgekühlt
air cooled /
refroidissement par air /
refrigerada por aire

TBi 380 Aut

60% (10 min.)
Mix: 360 A
CO₂: 380 A
Ø 1.2-1.6 mm

luftgekühlt
air cooled /
refroidissement par air /
refrigerada por aire



TBi 7W Aut

100% (10 min.)
 Mix: 450 A
 CO₂: 500 A
 Ø 1.0-1.6 mm

wassergekühlt
 water cooled /
 refroidissement par eau /
 refrigerada por agua



TBi 8W Aut

100% (10 min.)
 Mix: 500 A
 CO₂: 550 A
 Ø 1.2-3.2 mm

wassergekühlt
 water cooled /
 refroidissement par eau /
 refrigerada por agua



TBi 9W Aut

100% (10 min.)
 Mix: 500 A
 CO₂: 550 A
 Ø 1.0-1.6 mm

2-Kreis Kühlung
 2-circuit cooling /
 refroidissement en 2 circuits /
 2 circuitos de refrigeración



TBi 9W 3C Aut

100% (10 min.)
 Mix: 600 A
 CO₂: 650 A
 Ø 1.2-1.6 mm

3-Kreis Kühlung
 3-circuit cooling /
 refroidissement en 3 circuits /
 3 circuitos de refrigeración



TBi 10W Aut

100% (10 min.)
 Mix: 650 A
 CO₂: 700 A
 Ø 1.6-3.2 mm

2-Kreis Kühlung
 2-circuit cooling /
 refroidissement en 2 circuits /
 2 circuitos de refrigeración



TBi 241 Aut

100% (10 min.)
 Mix: 280 A
 CO₂: 310 A
 Ø 0.8-1.2 mm

wassergekühlt
 water cooled /
 refroidissement par eau /
 refrigerada por agua



TBi 351 Aut

100% (10 min.)
 Mix: 280 A
 CO₂: 320 A
 Ø 0.8-1.2 mm

wassergekühlt
 water cooled /
 refroidissement par eau /
 refrigerada por agua



TBi 511 Aut

100% (10 min.)
 Mix: 450 A
 CO₂: 500 A
 Ø 1.0-1.6 mm

wassergekühlt
 water cooled /
 refroidissement par eau /
 refrigerada por agua

Erleben Sie die TBI-Vorteile

- Flexibles und sehr robustes Koaxialkabel
- Haltbares Schlauchpaket mit großem Federknickschutz
- Hochwertige Verarbeitung und lange Lebensdauer

Experience the TBI-advantages

- Flexible and very robust coaxial cable
- Wear resistant cable assembly with spring support
- Highest-quality workmanship and long life

Faites l'expérience des avantages TBI

- Câble coaxial flexible et robuste
- Faisceau résistant avec ressort de protection
- Usinage et durée de fonctionnement supérieurs

Experimenten las ventajas TBI

- Cable coaxial flexible y robusto
- Paquete de mangueras con muelle protectorista
- Elaboración y vida útil sobresaliente

Optionen / Options / Options / Opciones



Sonderausführung /
Custom design /
Construction spéciale /
Construcción especial



mit Absaugung /
with fume extraction /
Torche aspirante /
Antorcha de aspiración



Schutzrohr Alu /
Aluminum sheath tube /
Tube en aluminium /
Tubo de aluminio

Abmessungen / Dimensions / Dimensions / Dimensiones

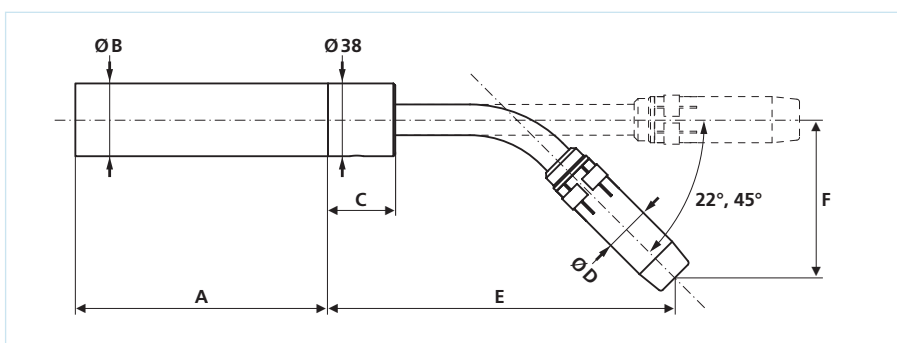

Modell / Model / Modèle / Modelo	A [mm]	B [mm]	C [mm]	D [mm]	E [mm]			F [mm]		
					0°	22°	45°	0°	22°	45°
TBi 5G Aut	164	37.0	35.0	20.0	190.0	184.0	163.6	0	32.1	69.9
TBi 6G Aut	164	37.0	47.5	24.0	262.0	252.8	221.5	0	49.5	106.6
TBi 7G Aut	164	37.0	35.0	24.0	221.3	213.6	187.7	0	41.3	87.3
TBi 8G Aut	164	37.0	47.5	24.0	281.5	256.7	230.3	0	56.4	113.2
TBi 5W Aut	164	37.0	47.5	20.0	202.5	196.5	176.1	0	32.1	69.9
TBi 7W Aut	164	37.0	47.5	24.0	212.5	204.4	177.3	0	43.3	91.1
TBi 8W Aut	156	44.0	35.0	24.0	283.0	-	249.3	0	-	106.1
TBi 9W Aut	164	37.0	47.5	24.0	225.5	217.2	189.6	0	44.1	94.1
TBi 9W 3C Aut	156	44.0	35.0	28.0	213.0	-	-	0	-	-
TBi 10W Aut	156	44.0	35.0	31.0	251.0	-	-	0	-	-
TBi 150 Aut	164	37.0	2.0	18.0	150.0	-	117.6	0	-	75.6
TBi 240 Aut	164	37.0	35.0	21.0	188.5	-	156.2	0	-	84.3
TBi 250 Aut	164	37.0	35.0	23.0	173.8	167.5	145.1	0	35.5	76.3
TBi 360 Aut	164	37.0	35.0	25.5	221.0	212.5	184.4	0	45.2	94.6
TBi 380 Aut	164	37.0	47.5	25.5	274.0	-	-	0	-	-
TBi 241 Aut	164	37.0	35.0	21.0	188.5	181.4	157.3	0	38.2	81.5
TBi 351 Aut	164	37.0	35.0	23.0	173.8	-	145.1	0	-	76.3
TBi 511 Aut	164	37.0	35.0	25.5	212.0	204.8	180.7	0	38.5	81.9

© 2009 TBi Industries GmbH. Alle Rechte vorbehalten. Technische Änderungen vorbehalten. Kopie oder Nachdruck auch auszugsweise nicht gestattet. / All rights reserved. Subject to change without notice. Excerpts and reprints not permitted. / Tous droits réservés. Sous réserve de modifications techniques. Copie/reproduction même partielle non autorisée. / Todos derechos reservados. TBi se reserva modificaciones técnicas. Copia y reimpression, tampoco en partes, no permitido. Nr. DOKP11700C, 10/2009.